



F380B

english

italiano

français

deutsch

español

nederlands



cranes without compromise

FASSI

CRANES WITHOUT COMPROMISE





FASSI

F380B



GB The Fassi cranes are developed from a design undertaking aimed at creating products that are market leaders, in terms of both performance and safety. Fassi designers work with the most advanced computer science, virtually simulating what will actually happen when the crane is being used: strict exertion tests applied to the prototypes confirm the validity of the design expectations. The attention to quality begins with the choice of materials and is repeated in the structural details, from the steels to the ecological paintwork applied with procedures able to guarantee the highest levels of chemical and physical resistance and consistency over time.

Design according to European Regulation EN12999*. Fatigue-tested in class H1B3.

IT Le gru Fassi nascono da un impegno di progettazione finalizzato a realizzare prodotti ai massimi livelli di mercato, nelle prestazioni come nella sicurezza. I progettisti Fassi lavorano con l'informatica più avanzata simulando in modo virtuale quello che avverrà concretamente nell'impiego della gru: prototipazione con severe prove a fatica confermano la validità delle aspettative progettuali. Le attenzioni qualitative iniziano con la scelta dei materiali e si confermano nei particolari costruttivi, dagli acciai alla verniciatura ecologica eseguita con procedure capaci di assicurare le più elevate resistenze chimico-fisiche e inalterabilità nel tempo.

Progettazione conforme alla Normativa Europea EN12999*. Classe di collaudo a fatica H1B3.

FR Les grues FASSI sont développées depuis une étude de projet visant à la création de produits haut niveau sur le marché, tant sur le plan de la performance que celui de la sécurité. Les concepteurs FASSI travaillent avec un système informatique des plus avancé, capable de simuler de manière virtuelle ce qui se passe lors de l'utilisation de la grue : des prototypes sont soumis à des tests de résistance à fatigue afin de confirmer la validité des résultats en adéquation au projet. La qualité élevée des matériaux choisis est confirmée dans les détails de construction, du choix des aciers, jusqu'à celui de la peinture écologique réalisée avec des procédés garantissant les résistances chimiques et physiques les plus élevées et d'inaltérabilité dans le temps.

Etude de projet conforme à la norme européenne EN12999*. Essais en fatigue en classe H1B3.

ES Las grúas Fassi nacen de un compromiso de proyecto destinado a realizar productos que estén al máximo nivel del mercado, tanto por lo que se refiere a las prestaciones, como a la seguridad. Los proyectistas Fassi trabajan con los sistemas informáticos más avanzados simulando de forma virtual lo que ocurrirá concretamente durante el uso de la grúa: la producción de prototipos con severas pruebas de fatiga confirma la validez de las previsiones del proyecto. La alta exigencia de calidad empieza por la elección de los materiales y se confirman en los detalles de construcción, desde los aceros a la pintura ecológica realizada con procedimientos que pueden asegurar las más elevadas resistencias químico-físicas y la inalterabilidad en el tiempo.

Proyecto según Normativa Europea EN12999*. Comprobación de fatiga en la clase H1B3.

DE De Kräne von Fassi entstehen aus Engagement für die Konstruktion von Produkten auf höchstem Marktniveau sowohl was Leistung als auch Sicherheit betrifft. Die Konstrukteure von Fassi arbeiten mit den fortgeschrittensten Informatikprogrammen und simulieren auf virtuelle Weise was später beim Einsatz des Krans genau geschieht: Prototypentwicklung mit strengen Ermüdungstests bestätigen die Gültigkeit der Projekterwartungen. Die Qualitätskontrolle beginnt mit der Materialauswahl und geht weiter mit den Konstruktionsdetails, von den Stählen bis zur umweltfreundlicher Lackierung mit einer Prozedur, die höchste chemisch-physikalische Widerstandsfähigkeit und Haltbarkeit auf lange Zeit gewährleistet.

Berechnungsnorm EN12999*. Ermüdungstest nach Klasse H1B3.

NL De hijskranen van Fassi zijn het resultaat van inspanningen bij het ontwerpen die gericht zijn op het bouwen van producten op het maximumniveau dat op de markt bestaat, zowel wat de prestaties als de veiligheid betreft. De ontwerpers van Fassi maken gebruik van de meest geavanceerde informaticamiddelen om op virtuele wijze te simuleren wat er feitelijk gebeurt als de hijskraan gebruikt wordt: prototypes die strenge vermoeidheidstesten ondergaan bevestigen de geldigheid van de verwachtingen van het ontwerp. De aandacht voor de kwaliteit begint bij de keuze van de materialen en gaat verder met de constructiedetails, van het staal tot het milieuvriendelijke lakwerk dat aangebracht wordt met procedures die een hoge chemisch-fysische weerstand en de onaantastbaarheid door de tijd heen verzekeren.

Het ontwerp van de kraan komt overeen met de Europese Norm EN12999*. Vermoeidheidscontrole in de klasse H1B3.

*For EC markets - Per mercati CE - Pour les marchés CE - Para los mercados CE - Für CE Märkte - Voor EG markten



F380B

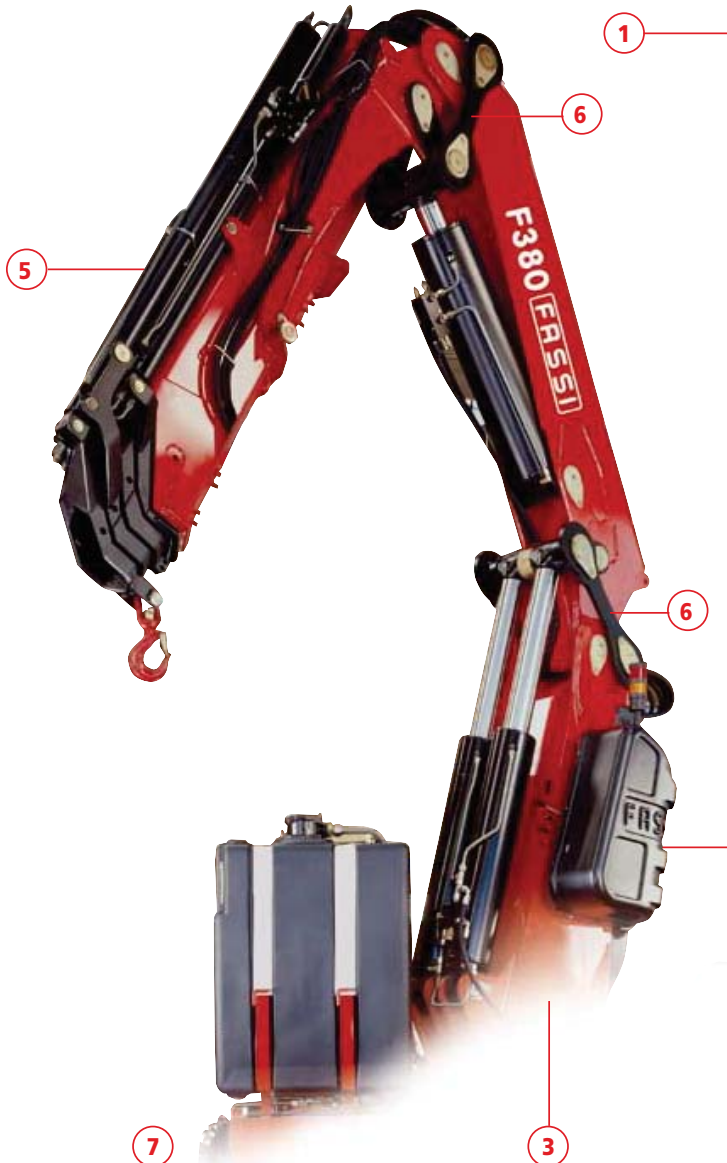

- GB**
- 1) "Flow sharing" Digital hydraulic distributor and RCH Evolution remote control
 - 2) Fx electronic control system
 - 3) Rack rotation
 - 4) Recycling and XF valves
 - 5) MPES system
 - 6) Linkages
 - 7) ProLink

- IT**
- 1) Distributore idraulico digitale flow sharing e radiocomando RCH Evolution
 - 2) Sistema di controllo elettronico FX
 - 3) Rotazione a cremagliera
 - 4) Valvola XF e rigenerativa
 - 5) Sistema MPES
 - 6) Bielle
 - 7) ProLink



- FR**
- 1) Distributeur hydraulique digital "flow sharing et radiocommande RCH Evolution
 - 2) Système électronique de contrôle FX
 - 3) Rotation à crémaillère
 - 4) Valves XF et régénératrice d'huile
 - 5) MPES système
 - 6) Biellettes
 - 7) Système ProLink

- ES**
- 1) Distribuidor hidráulico digital "flow sharing y radiocomando RCH Evolution
 - 2) Sistema electrónico de control FX
 - 3) Rotación a cremallera
 - 4) Válvulas XF y regeneradora del aceite
 - 5) System MPES
 - 6) Bielas
 - 7) Sistema ProLink

- DE**
- 1) Digitaler Steuerblock mit Flow sharing und der RCH-Funkfern-steuerung
 - 2) FX-System, die elektronische Lastmomentbegrenzung
 - 3) Zahnstangen-Schenkwerk
 - 4) Schnellgang- und XF-System-Ventile
 - 5) Multi-Power Ausschubsystem
 - 6) Kniehebelsystem
 - 7) PROLINK

- NL**
- 1) "Flow sharing" digitaal aangestuurd hydraulisch ventielblok en RCH Evolutie radiografische afstandsbediening
 - 2) FX elektronisch beveiligingssysteem
 - 3) Zwenken middels tandheugelsysteem
 - 4) Retouroliehergebruik- en XF - veiligheidsventielen
 - 5) MPES-systeem
 - 6) Kniehevelsystemen
 - 7) ProLink

FASSI

evolution
CONCEPT

F380B.22

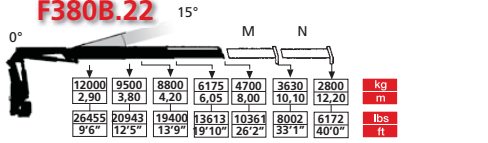

F380B.23

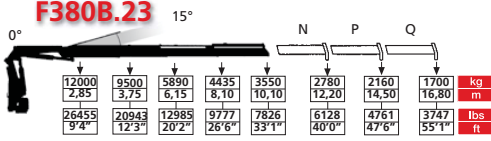

F380B.24

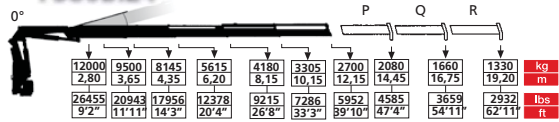

F380BC.24

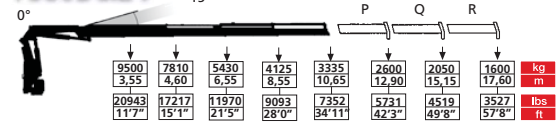

F380B.25

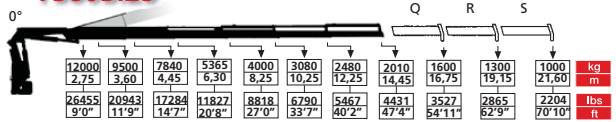

F380BC.25

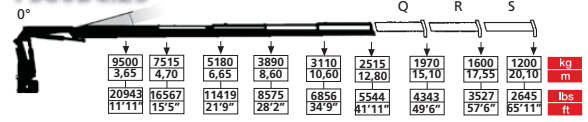

F380B.26

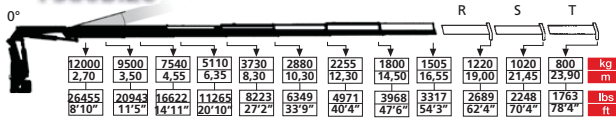

F380BC.26

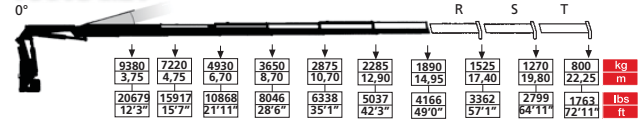

F380B.27

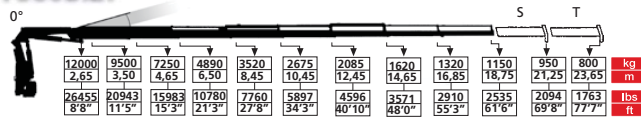

F380B.28

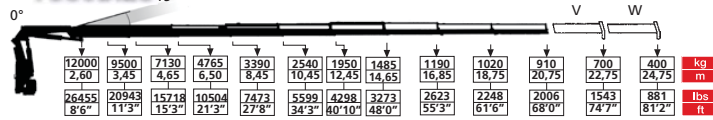

	tm	lbs.ft	m	ft	°	kNm	lbs.ft	Mpa	psi	l/min	gal/min	oil	gal	kg	lbs
F380B.22	37,6	271961	8,00	26'2"	430	47,5	35035	31	4496	60-80	16-21	180	48	4080	8994
F380B.23	36,2	261973	10,10	33'1"	430	47,5	35035	31	4496	60-80	16-21	180	48	4330	9545
F380B.24	35,4	256265	12,15	39'10"	430	47,5	35035	31	4496	60-80	16-21	180	48	4580	10097
F380BC.24	35,9	259882	10,65	34'11"	430	47,5	35035	31	4496	60-80	16-21	180	48	4380	9656
F380B.25	34,8	251708	14,45	47'4"	430	47,5	35035	31	4496	60-80	16-21	180	48	4830	10648
F380BC.25	35,3	255470	12,80	41'11"	430	47,5	35035	31	4496	60-80	16-21	180	48	4600	10141
F380B.26	34,3	248164	16,55	54'3"	430	47,5	35035	31	4496	60-80	16-21	180	48	5080	11199
F380BC.26	35,1	254457	17,40	57'1"	430	47,5	35035	31	4496	60-80	16-21	180	48	4830	10648
F380B.27	33,7	243824	18,75	61'6"	430	47,5	35035	31	4496	60-80	16-21	180	48	5230	11530
F380B.28	33,1	239774	20,75	68'0"	430	47,5	35035	31	4496	60-80	16-21	180	48	5380	11860



F380B.24 L324

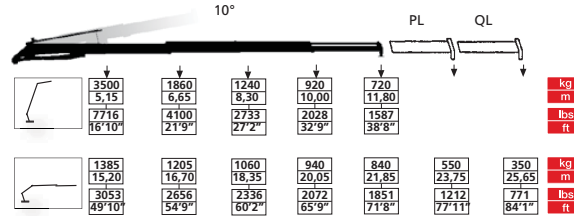

F380BC.24 L324

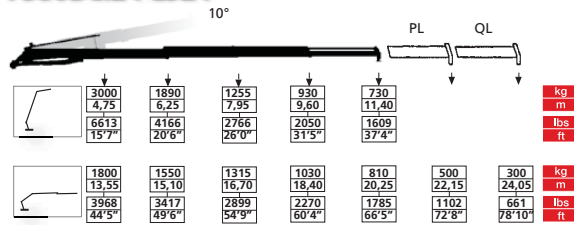

F380B.25 L324

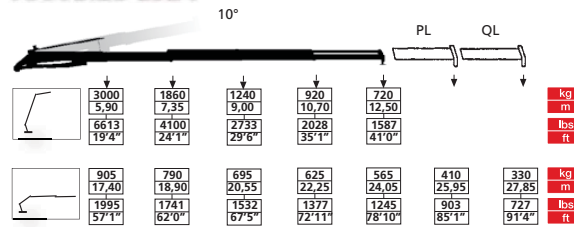

F380BC.25 L324

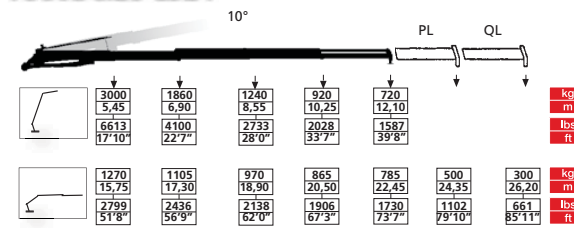

F380B.26 L214

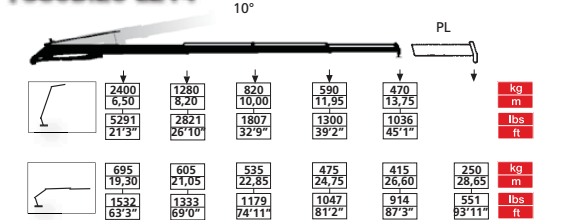

	tm	lbs.ft	m	ft	°	kNm	lbs.ft	Mpa	psi	l/min	gal/min	l	gal	kg	lbs
F380B.24 L324	35,4	256265	21,85	71'8"	430	47,5	35035	31,0	4496	60-80	16-21	180	48	5480	12081
F380BC.24 L324	35,9	259882	20,25	66'5"	430	47,5	35035	31,0	4496	60-80	16-21	180	48	5320	11728
F380B.25 L324	34,8	251708	24,05	78'10"	430	47,5	35035	31,0	4496	60-80	16-21	180	48	5700	12566
F380BC.25 L324	35,3	255470	22,45	73'7"	430	47,5	35035	31,0	4496	60-80	16-21	180	48	5540	12213
F380B.26 L214	34,3	248164	26,60	87'3"	430	47,5	35035	31,0	4496	60-80	16-21	180	48	5820	12830



F380B

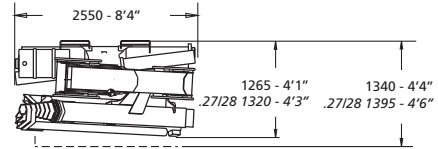
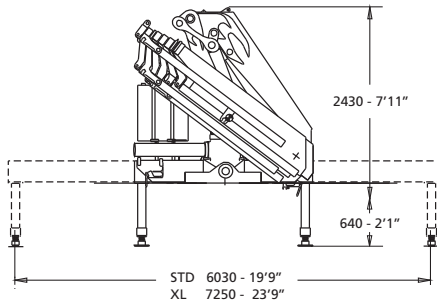

L SERIE

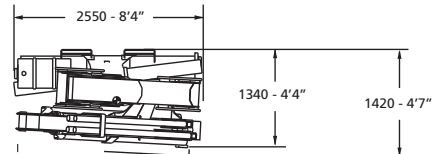
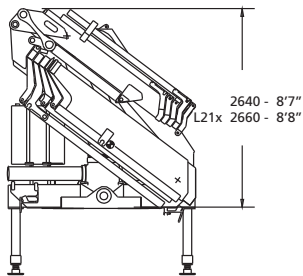

L214	650 kg/1432 lbs	L324	850 kg/1873 lbs	L414	850 kg /1873 lbs
PL	17 kg/ 37 lbs	PL	32 kg / 70 lbs	PL	32 kg / 70 lbs
		QL	22 kg / 48 lbs	QL	22 kg / 48 lbs



CPZ 09/06

Data and descriptions are approximate and not binding - Dati e dimensioni sono forniti a titolo indicativo e non impegnativo - Toutes les données et descriptions sont fournies à titre indicatif, sans engagement - Unverbindliche Angaben, Konstruktionsänderungen vorbehalten - Datos y descripciones todos a título indicativo y no imperativo - Specificaties zijn niet bindend, wijzigingen derhalve voorbehouden

FASSI

FASSI GRU S.p.A. - Via Roma, 110 - 24021 Albino (Bergamo) ITALY
Tel- +39 035 776400 - Fax +39 035 755020
<http://www.fassigroup.com> E-mail: fassi@fassigroup.com

COMPANY
WITH QUALITY MANAGEMENT
SYSTEM CERTIFIED BY DNV
=ISO 9001:2000=