



F510A



evolution
CONCEPT

english

italiano

français

deutsch

español

nederlands



cranes without compromise

FASSI

CRANES WITHOUT COMPROMISE



FASSI

evolution
CONCEPT

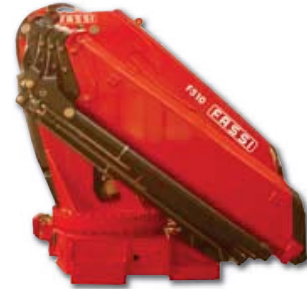

F510A.22

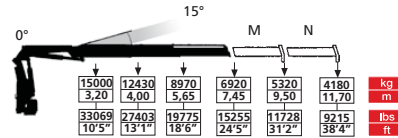

F510A.23

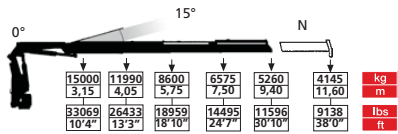

F510A.24

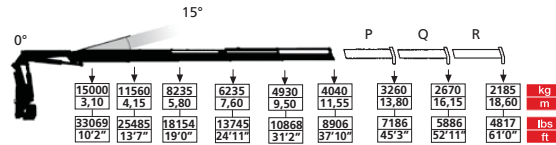

F510A.25

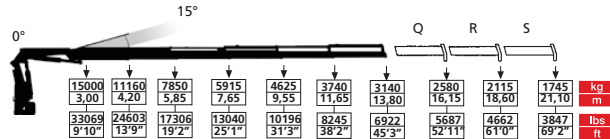

F510A.26

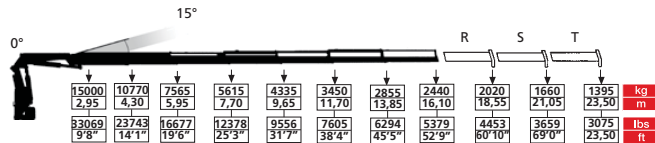

F510A.27

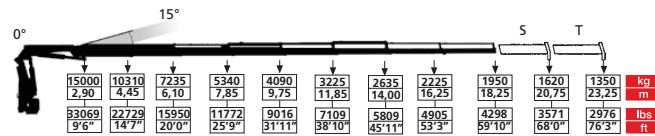

F510A.28

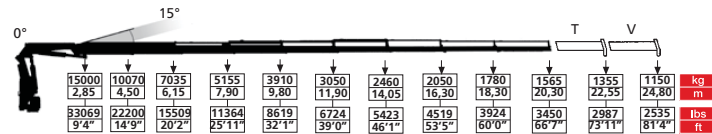

	T		m		°		kNm		Mpa		l/min		oil		kg	
	tm	lbs.ft	m	ft			kNm	lbs.ft	Mpa	psi	l/min	gal/min	l	gal	kg	lbs
F510A.22	51,5	372499	7,45	24'5"	360	CONTINUOUS	45,0	33199	31,5	4570	70-80	18-21	250	66	5000	11023
F510A.23	49,5	358033	9,40	30'10"	360	CONTINUOUS	45,0	33199	31,5	4570	70-80	18-21	250	66	5335	11761
F510A.24	48,0	347184	11,55	7'10"	360	CONTINUOUS	45,0	33199	31,5	4570	70-80	18-21	250	66	5665	12489
F510A.25	47,0	339951	13,80	45'3"	360	CONTINUOUS	45,0	33199	31,5	4570	70-80	18-21	250	66	5975	13172
F510A.26	46,5	336334	16,10	52'9"	360	CONTINUOUS	45,0	33199	31,5	4570	70-80	18-21	250	66	6265	13811
F510A.27	46,0	332718	18,25	59'10"	360	CONTINUOUS	45,0	33199	31,5	4570	70-80	18-21	250	66	6475	14274
F510A.28	45,5	329101	20,30	66'7"	360	CONTINUOUS	45,0	33199	31,5	4570	70-80	18-21	250	66	6655	14671

FASSI

F510A.25 L516

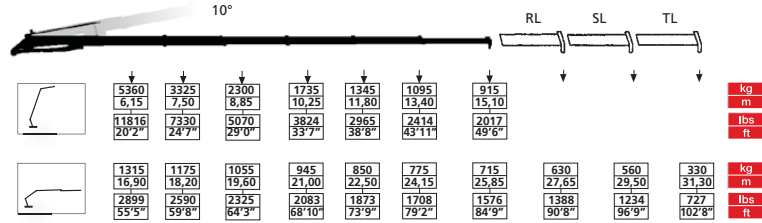

F510A.26 L426

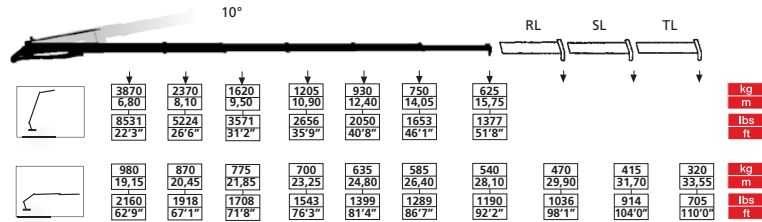

F510A.27 L426

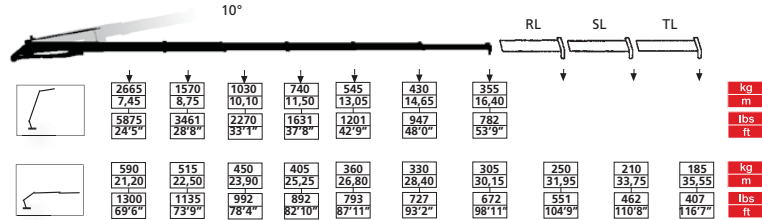

F510A.27 L214

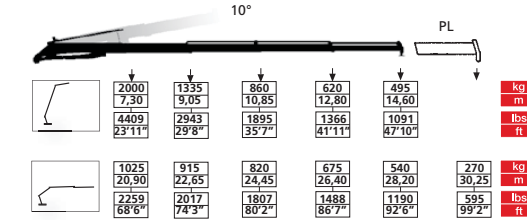

F510A.28 L214

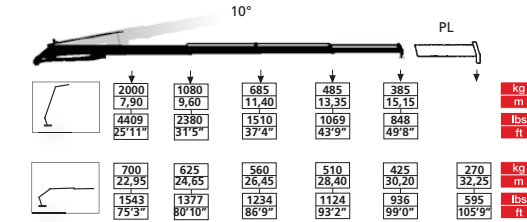

	tm	lbs.ft	m	ft	kNm	lbs.ft	Mpa	psi	l/min	gal/min	oil	kg	lbs			
F510A.25 L516	47,5	343567	25,85	84'9"	360	CONTINUOUS	45,0	33199	31,5	4570	70-80	18-21	250	66	7480	16490
F510A.26 L426	46,5	336334	28,10	92'2"	360	CONTINUOUS	45,0	33199	31,5	4570	70-80	18-21	250	66	7585	16721
F510A.27 L426	46,0	332718	30,15	98'11"	360	CONTINUOUS	45,0	33199	31,5	4570	70-80	18-21	250	66	7810	17217
F510A.27 L214	46,0	332718	28,20	92'6"	360	CONTINUOUS	45,0	33199	31,5	4570	70-80	18-21	250	66	7260	16005
F510A.28 L214	45,5	329101	30,20	99'0"	360	CONTINUOUS	45,0	33199	31,5	4570	70-80	18-21	250	66	7455	16435

F510A

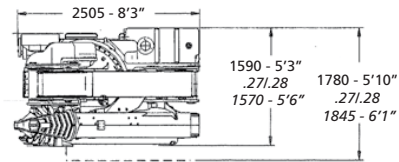
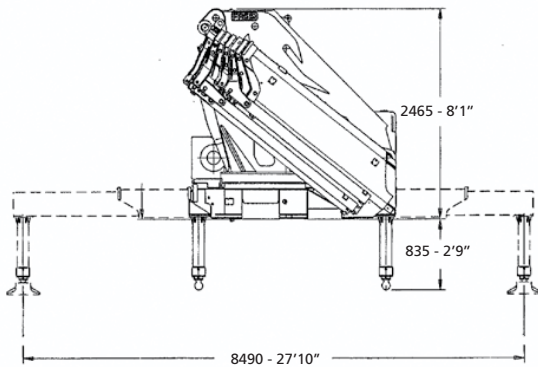

L SERIE

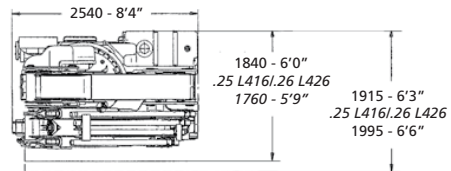
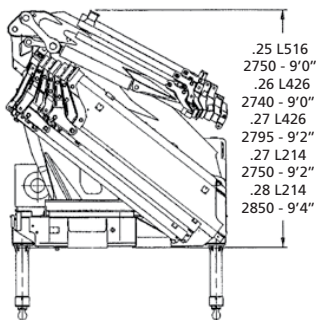

L214	650 kg / 1432 lbs	L426	1200 kg / 2645 lbs	L516	1400 kg / 3086 lbs
PL	21 kg / 46 lbs	RL	36 kg / 79 lbs	RL	36 kg / 79 lbs
		SL	25 kg / 55 lbs	SL	25 kg / 55 lbs
		TL	15 kg / 33 lbs	TL	15 kg / 33 lbs

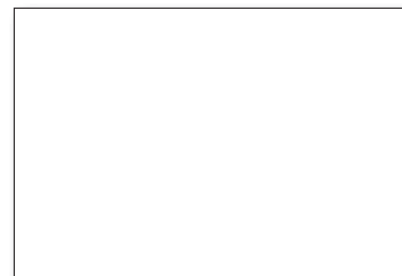

CPZ 04/2007

Dati e dimensioni sono forniti a titolo indicativo e non impegnativo - Toutes les données et descriptions sont fournies à titre indicatif, sans engagement - Unverbindliche Angaben, Konstruktionsänderungen vorbehalten
Data and descriptions are approximate and not binding - Datos y descripciones todos a título indicativo y no imperativo - Specificaties zijn niet bindend, wijzigingen derhalve voorbehouden

FASSI GRU S.p.A. - Via Roma, 110 - 24021 Albino (Bergamo) ITALY
Tel: +39 035 776400 - Fax +39 035 755020
<http://www.fassigroup.com> E-mail: fassig@fassigroup.com

COMPANY
WITH QUALITY MANAGEMENT
SYSTEM CERTIFIED BY DNV
= ISO 9001:2000 =

